

# WORKSTATION

SERIES

08

SECTION



 **APEX**  
**S-SYSTEM**  
OPEN PLAN

FLEXIBLE DESIGN AND INTERACTIVE CONCEPT

CONCEPT | 01



## 2 SEATER WORKSTATION



MODEL	DESCRIPTION	QTY
PT-FFOT-135x80	FULL FABRIC W/O TRUNKING SIZE: 1350H x 800Wmm	2 nos
PT-FFOT-120x150	FULL FABRIC W/O TRUNKING SIZE: 1200H x 1500Wmm	2 nos
PT-HGCT-120x75	HALF GLASS C/W CENTRE TRUNKING SIZE: 1200H x 750Wmm	4 nos
PT-CP120	CORNER POST SIZE: 1200Hmm	2 nos
PT-JP 135	JOINT POST SIZE: 1350Hmm	1 no
PT-JP 120	JOINT POST SIZE: 1200Hmm	4 nos
PT-EP120	END POST SIZE: 1200Hmm	2 nos
PT-CUS-EP	END POST SIZE: 150Hmm	2 nos
WK-HB 80	HANGING BOOKSHELF SIZE: 785W x 320D x 240Hmm	2 nos
WK-M-LS15	MCAB SINGLE SEATER TABLE C/W GROMMET SIZE: 1500W/600D x 1500W/600D x 760H mm	2 nos
WK-M-3D	MCAB 3 DRAWER SIZE: 425W x 490D x 540H mm	2 nos
WK-M-16M-BD	MCAB 1600W COMBI STORAGE SIZE: 1600W x 450D x 760H mm	1 no

\* FRAME COLOUR : WHITE  
\* THE ABOVE MODEL EXCLUDING DISPLAY ACCESSORIES

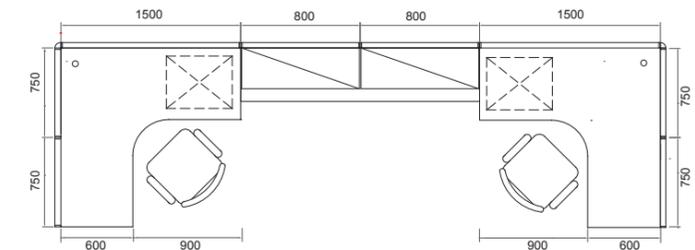

CONCEPT | 02

## 2 SEATER WORKSTATION

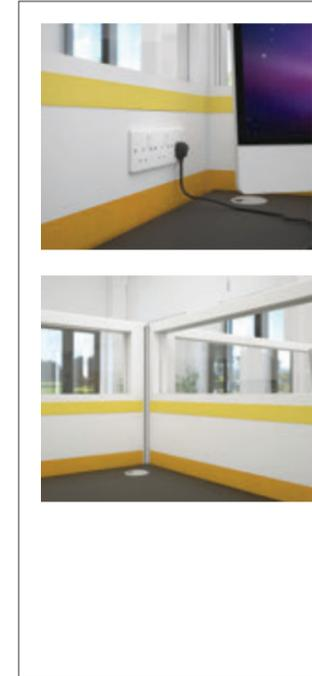

MODEL	DESCRIPTION	QTY
PT-FFOT-135x90	FULL FABRIC W/O TRUNKING SIZE: 1350H x 900Wmm	2 nos
PT-FFOT-135x45	FULL FABRIC W/O TRUNKING SIZE: 1350H x 450Wmm	2 nos
PT-HGCT-120x150	HALF GLASS C/W CENTRE TRUNKING SIZE: 1200H x 1500Wmm	2 nos
PT-HGCT-120x75	HALF GLASS C/W CENTRE TRUNKING SIZE: 1200H x 750Wmm	2 nos
PT-FGOT-120x90	FULL GLASS W/O TRUNKING SIZE: 1200H x 900Wmm	2 nos
PT-CP135	CORNER POST SIZE: 1350H mm	2 nos
PT-TP135	TEE POST SIZE: 1350H mm	1 no
PT-JP120	JOINT POST SIZE: 1200H mm	5 nos
PT-EP120	END POST SIZE: 1200Hmm	3 nos
PT-CUS-EP	END POST SIZE: 150Hmm	4 nos
WK-CCW-150 x 60	CURVE CORNER WORKTOP SIZE: 1500W/600D x 1500W/600D x 25THK mm	2 nos
RD-02 (R)	TABLE LEG	2 nos
RD-02 (L)	TABLE LEG	2 nos
WK-ML-M3D	MOBILE 3 DRAWER SIZE: 425W x 490D x 540H mm	2 nos
WK-ML-130-D2	SLIDING HALF HEIGHT CABINET SIZE: 900W x 450D x 1300H mm	2 nos
PT-BK-01-F	LEFT BRACKET (BIG)	1 no
PT-BK-02-F	RIGHT BRACKET (BIG)	1 no

\* FRAME COLOUR : WHITE  
\* THE ABOVE MODEL EXCLUDING DISPLAY ACCESSORIES

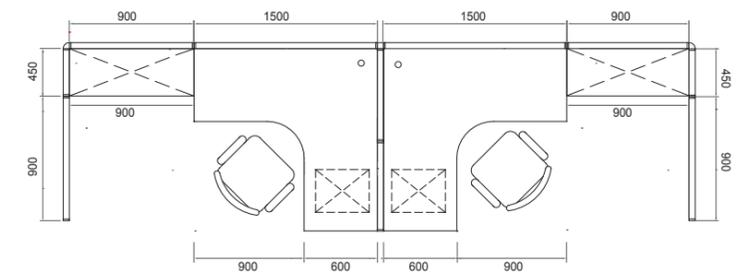

CONCEPT | 01



## 4 SEATER WORKSTATION



MODEL	DESCRIPTION	QTY
PT-FFDT-135x75	FULL FABRIC C/W DOUBLE TRUNKING SIZE: 1350H x 750Wmm	2 nos
PT-FFOT-105x150	FULL FABRIC W/O TRUNKING SIZE: 1050H x 1500Wmm	1 no
PT-HGDT-135x75	HALF GLASS C/W DOUBLE TRUNKING SIZE: 1350H x 750Wmm	2 nos
PT-HGDT-135x45	HALF GLASS C/W DOUBLE TRUNKING SIZE: 1350H x 450Wmm	2 nos
PT-HGOT-120x150	HALF GLASS W/O TRUNKING SIZE: 1200H x 1500Wmm	2 nos
PT-TP105	TEE POST SIZE: 1050Hmm	1 no
PT-CP120	CORNER POST SIZE: 1200Hmm	2 nos
PT-JP135	JOINT POST SIZE: 1350Hmm	4 nos
PT-EP120	END POST SIZE: 1200Hmm	2 nos
PT-EP105	END POST SIZE: 1050Hmm	1 no
PT-CUS-EP	END POST SIZE: 300Hmm	1 no
PT-CUS-EP	END POST SIZE: 150Hmm	2 nos
WK-HB75	HANGING BOOKSHELF SIZE: 735W x 320D x 240Hmm	4 nos
WK-M-15(P)	MCAB STANDARD DESK WITH ALUMINIUM PROFILE SIZE: 1500W x 740D x 760Hmm	2 nos
WK-M-LS15	MCAB SINGLE SEATER TABLE C/W GROMMET SIZE: 1500W/600D x 1500W/600D x 760Hmm	2 nos
WK-M-16S-BEF	MCAB 1600W COMBI (sliding+mobile+ CPU storage) SIZE: 1600W x 450D x 650Hmm	2 nos
WK-M-3D	MCAB 3 DRAWER SIZE: 425W x 490D x 540Hmm	2 nos

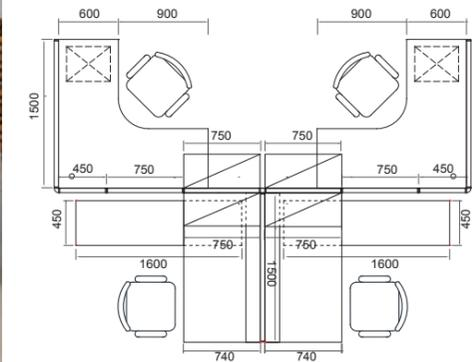

\* FRAME COLOUR : WHITE  
\* THE ABOVE MODEL EXCLUDING DISPLAY ACCESSORIES





CONCEPT | 01

# ADMINISTRATOR WORKSTATION

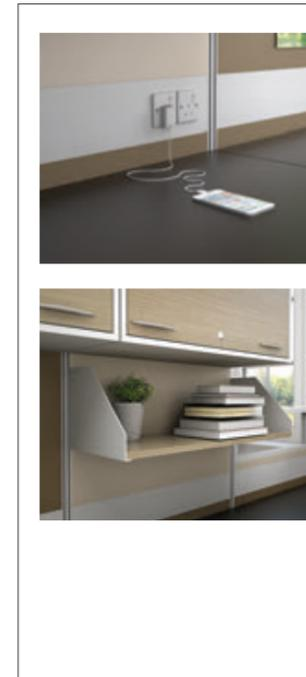

MODEL	DESCRIPTION	QTY
PT-HGCT-120x75	HALF GLASS C/W CENTER TRUNKING SIZE: 1200H x 750Wmm	11 nos
PT-FFCT-180x75	FULL FABRIC C/W CENTRE TRUNKING SIZE: 1800H x 750Wmm	2 nos
PT-FFCT-180x80	FULL FABRIC C/W CENTRE TRUNKING SIZE: 1800H x 800Wmm	1 no
PT-EP120	END POST SIZE: 1200Hmm	3 nos
PT-CUS-EP	END POST SIZE: 600Hmm	2 nos
PT-JP120	JOINT POST SIZE: 1200Hmm	7 nos
PT-JP180	JOINT POST SIZE: 1800Hmm	2 nos
PT-TP120	TEE POST SIZE: 1200Hmm	1 no
PT-CP120	CORNER POST SIZE: 1200Hmm	2 nos
WK-HC75(SF)	HANGING CABINET-FLIP DOOR TYPE WITH SOFT CLOSING SIZE: 735W x 355D x 445Hmm	2 nos
WK-HC80(SF)	HANGING CABINET-FLIP DOOR TYPE WITH SOFT CLOSING SIZE: 785W x 355D x 445Hmm	1 no
WK-HB75	HANGING BOOKSHELF WITH SOFT CLOSING SIZE: 735W x 355D x 445Hmm	2 nos
WK-M-LS15	MCAB SINGLE SEATER TABLE C/W GROMMET SIZE: 1500W/600D x 1500W x 600Dmm	2 nos
WK-DSC-22	MCAB SQUARE DISCUSSION TABLE SIZE: 900W x 900D x 760Hmm	1 no
WK-M-8M-A	MCAB SWING STORAGE SIZE: 800W x 450D x 760Hmm	1 no
WK-M-3D	MCAB MOBILE SIZE: 480W x 450D x 650Hmm	2 nos

\*FRAME COLOUR - WHITE  
\*THE ABOVE MODEL EXCLUDING DISPLAY ACCESSORIES

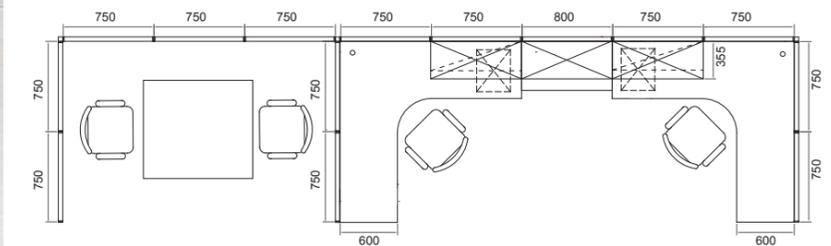

CONCEPT | 02



# ADMINISTRATOR WORKSTATION



MODEL	DESCRIPTION	QTY
PT-HGCT-120x80	HALF GLASS C/W CENTER TRUNKING SIZE: 1200H x 800Wmm	10 nos
PT-FFCT-180x80	FULL FABRIC C/W CENTRE TRUNKING SIZE: 1800H x 800Wmm	6 nos
PT-HGCT-180x80	HALF GLASS C/W CENTRE TRUNKING SIZE: 1800H x 800Wmm	2 nos
PT-FGOT-120x80	FULL GLASS WITHOUT TRUNKING SIZE: 1200H x 800Wmm	1 nos
PT-FGOT-180x80	FULL GLASS WITHOUT TRUNKING SIZE: 1800H x 800Wmm	3 nos
PT-EP120	END POST SIZE: 1200Hmm	2 nos
PT-CUS-EP	END POST SIZE: 600Hmm	3 nos
PT-EP180	END POST SIZE: 1800Hmm	1 no
PT-JP120	JOINT POST SIZE: 1200Hmm	7 nos
PT-JP180	JOINT POST SIZE: 1800Hmm	7 nos
PT-TP120	TEE POST SIZE: 1200Hmm	1 no
PT-CP120	CORNER POST SIZE: 1200Hmm	2 nos
PT-CP180	CORNER POST SIZE: 1800Hmm	2 nos
WK-HC80(SF)	HANGING CABINET-FLIP DOOR TYPE WITH SOFT CLOSING SIZE: 785W x 355D x 445Hmm	5 nos
WK-HB80	HANGING BOOKSHELF WITH SOFT CLOSING SIZE: 785W x 355D x 445Hmm	3 nos
WK-M15-2S (P)	MCAB 2 SEATER WITH ALUMINIUM PROFILE SIZE: 1500W x 1480W x 760Dmm	1 no
WK-M-18 (F)	MCAB STANDARD DESK WITH FLIPPER CASING SIZE: 1800W x 740D x 760Hmm	1 no
PT-M-PAR15 (P)	A2S PARTITION SIZE: 1350W x 300H	1 no
WK-M-16S-AD	MCAB 1600W COMBI STORAGE SLIDING + HALF SWING SIZE: 1600W x 450D x 760Hmm	1 no
WK-M-3D	MCAB MOBILE SIZE: 480W x 450D x 650Hmm	2 nos

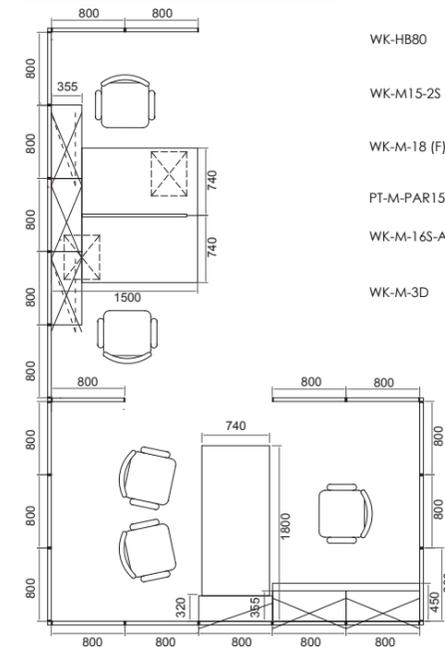

\*FRAME COLOUR : WHITE  
\*THE ABOVE MODEL EXCLUDING DISPLAY ACCESSORIES



CONCEPT | 01



# EXECUTIVE WORKSTATION



MODEL	DESCRIPTION	QTY
PT-FFDT-180x45	FULL FABRIC C/W DOUBLE TRUNKING SIZE: 1800H x 450Wmm	1 nos
PT-FFDT-180x90	FULL FABRIC C/W DOUBLE TRUNKING SIZE: 1800H x 900Wmm	2 nos
PT-FFDT-180x75	FULL FABRIC C/W DOUBLE TRUNKING SIZE: 1800H x 750Wmm	1 nos
PT-HGDT-135x90	HALF GLASS C/W DOUBLE TRUNKING SIZE: 1350H x 900Wmm	1 no
PT-HGDT-135x45	HALF GLASS C/W DOUBLE TRUNKING SIZE: 1350H x 450Wmm	1 no
PT-FGOT-135x90	FULL GLASS W/O TRUNKING SIZE: 1350H x 900Wmm	1 no
PT-FGOT-135x45	FULL GLASS W/O TRUNKING SIZE: 1350H x 450Wmm	1 no
PT-TP135	TEE POST SIZE: 1350Hmm	1 no
PT-JP135	JOINT POST SIZE: 1350Hmm	2 nos
PT-JP180	JOINT POST SIZE: 1800Hmm	4 nos
PT-EP135	END POST SIZE: 1350Hmm	1 no
PT-EP180	END POST SIZE: 1800Hmm	1 no
WK-WT-90x45	STRAIGHT WORKTOP SIZE: 900W x 450Dmm	2 nos
WK-HC90(SF)	HANGING CABINET-FLIP DOOR TYPE WITH SOFT CLOSING SIZE: 885W x 355D x 445Hmm	2 nos
WK-HC75(SF)	HANGING CABINET-FLIP DOOR TYPE WITH SOFT CLOSING SIZE: 735W x 355D x 445Hmm	1 no
WK-HB90	HANGING CABINET-FLIP DOOR TYPE WITH SOFT CLOSING SIZE: 885W x 320D x 240Hmm	1 no
WK-M-EXEC-18(T)	MCAB EXECUTIVE TABLE WITH LARGE FLIPER CASING SIZE: 1800W x 740D x 760Hmm	1 no
WK-M-16M-BD	MCAB 1600W COMBINATION STORAGE SLIDING + HALF SWING SIZE: 1600W x 450D x 760Hmm	1 no
WK-M-8L-B	MCAB 1300H STORAGE(SLIDING) SIZE: 800W x 450D x 1300Hmm	1 no
WK-M-H3D	MCAB 3 DRAWER HIGH SIZE: 425W x 490D x 650Hmm	1 no

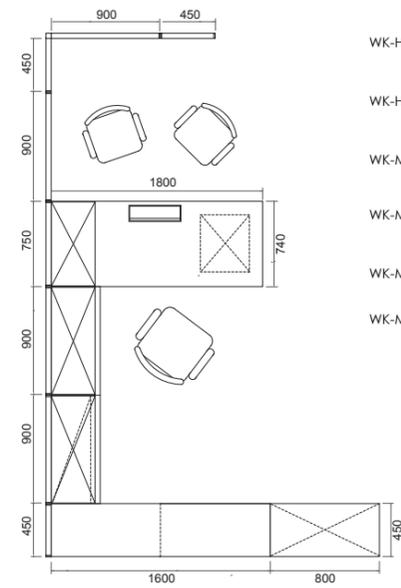

\*FRAME COLOUR : WHITE  
\*THE ABOVE MODEL EXCLUDING DISPLAY ACCESSORIES



CONCEPT | 02



# EXECUTIVE WORKSTATION



MODEL	DESCRIPTION	QTY
PT-FFCT-180x90	FULL FABRIC C/W CENTER TRUNKING SIZE: 1800H x 900Wmm	3 nos
PT-HGDT-135x45	HALF GLASS C/W DOUBLE TRUNKING SIZE: 1350H x 450Wmm	2 no
PT-HGOT-135x45	HALF GLASS W/O TRUNKING SIZE: 1350H x 450Wmm	1 no
PT-HGDT-135x90	HALF GLASS C/W DOUBLE TRUNKING SIZE: 1350H x 900Wmm	2 nos
PT-FFDT-135x90	FULL FABRIC C/W DOUBLE TRUNKING SIZE: 1350H x 900Wmm	1 no
PT-HGOT-135x90	HALF GLASS W/O TRUNKING SIZE: 1350H x 900Wmm	1 no
PT-FGOT-135x90	FULL GLASS W/O TRUNKING SIZE: 1350H x 900Wmm	3 nos
PT-TP135	TEE POST SIZE: 1350Hmm	3 nos
PT-JP135	JOINT POST SIZE: 1350Hmm	7 nos
PT-JP180	JOINT POST SIZE: 1800Hmm	7 nos
PT-EP135	END POST SIZE: 1350Hmm	2 nos
PT-CUS-WT	CUSTOMADE END POST SIZE: 450Hmm	2 nos
WK-HC90(SF)	HANGING CABINET-FLIP DOOR TYPE WITH SOFT CLOSING SIZE: 885W x 355D x 445Hmm	3 nos
WK-M-EXEC-18(T)	MCAB EXECUTIVE TABLE WITH LARGE FLIPER CASING SIZE: 1800W x 740D x 760Hmm	1 no
WK-M-16M-BD	MCAB 1600W COMBINATION STORAGE SLIDING + HALF SWING SIZE: 1600W x 450D x 760Hmm	1 no

\*FRAME COLOUR : DARK GREY  
\*THE ABOVE MODEL EXCLUDING DISPLAY ACCESSORIES

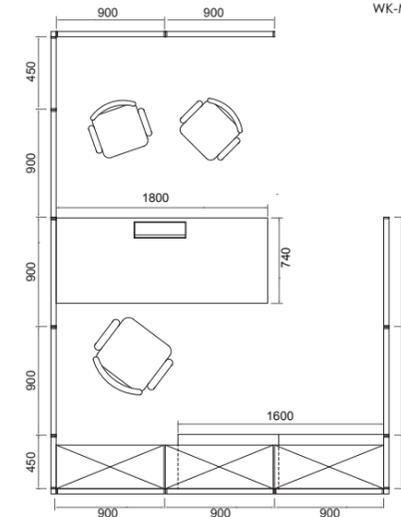



# RECEPTION COUNTER

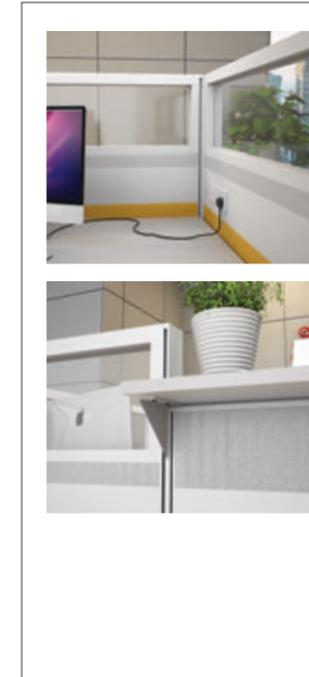

MODEL	DESCRIPTION	QTY
PT-FFCT-105x75	FULL FABRIC C/W CENTER TRUNKING SIZE: 1050H x 750Wmm	2 nos
PT-HGCT-120x75	HALF GLASS C/W CENTER TRUNKING SIZE: 1200H x 750Wmm	4 nos
PT-HGCT-120x45	HALF GLASS C/W CENTER TRUNKING SIZE: 1200H x 450Wmm	2 nos
PT-CP120	CORNER POST SIZE: 1200Hmm	2 nos
PT-JP105	JOINT POST SIZE: 1050Hmm	3 nos
PT-JP120	JOINT POST SIZE: 1200Hmm	2 nos
PT-EP120	END POST SIZE: 1200Hmm	2 nos
PT-CUS-EP	END POST SIZE: 150Hmm	2 nos
WK-WT150x75	STRIGHT WORKTOP IN FULLY LIGHT GREY SIZE: 1500W x 750D x 25THKmm	2 nos
WK-C75x30	COUNTER TOP IN FULLY LIGHT GREY SIZE: 750W x 300D x 25THKmm	2 nos
WK-ML-M3D	MOBILE 3 DRAWER SIZE: 425W x 490D x 540Hmm	2 nos
WK-ML-130-D2	SLIDING HALF HEIGHT CABINET SIZE: 900W x 450D x 1300Hmm	2 nos
WK-ML-130-D	OPEN HALF HEIGHT SIZE: 900W x 450D x 1300Hmm	1 no
PT-BK-01-F	LEFT BRACKET (BIG)	2 nos
PT-BK-02-F	RIGHT BRACKET (BIG)	2 nos
PT-BK-03-F	LEFT BRACKET (SMALL)	1 no
PT-BK-04-F	RIGHT BRACKET (SMALL)	1 no
PT-BK-05-F	COUNTER BRACKET (LEFT)	4 nos
PT-BK-06-F	COUNTER BRACKET (RIGHT)	4 nos

\* FRAME COLOUR : WHITE  
\* THE ABOVE MODEL EXCLUDING DISPLAY ACCESSORIES

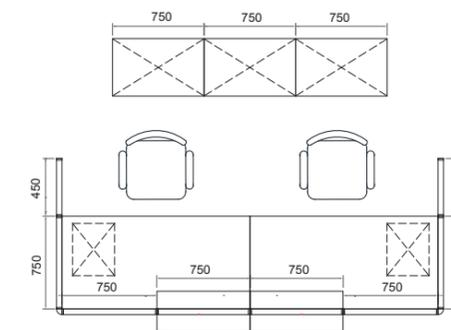

CONCEPT | 02



# RECEPTION COUNTER



MODEL	DESCRIPTION	QTY
PT-FFDT-120x120	FULL FABRIC C/W DOUBLE TRUNKING SIZE: 1200H x 1200Wmm	2 nos
PT-FFDT-105x150	FULL FABRIC C/W DOUBLE TRUNKING SIZE: 1050H x 1500Wmm	1 no
PT-JP105	JOINT POST SIZE: 1050Hmm	2 nos
PT-EP120	END POST SIZE: 1200Hmm	2 nos
PT-CUS-WT	CUSTOMMADE END POST SIZE: 150Hmm	2 nos
PT-BK-05-F	COUNTER SUPPORT BRACKET(LEFT) SIZE: 90W x 75Hmm	2 nos
PT-BK-06-F	COUNTER SUPPORT BRACKET(RIGHT) SIZE: 90W x 75Hmm	2 nos
WK-C-150-30	COUNTER TOP SIZE: 1500W x 300D x 25THKmm	1 no
WK-WT-120-75	STRAIGHT WORKTOP SIZE: 1200W x 750D x 25THKmm	2 nos
WK-WT-150-75	STRAIGHT WORKTOP SIZE: 1500W x 750D x 25THKmm	1 no
PT-BK-01-F	LEFT BRACKET(BIG) SIZE: 387W x 167Hmm	2 nos
PT-BK-02-F	RIGHT BRACKET(BIG) SIZE: 387W x 167Hmm	2 nos
WK-SL 75	SIDE SUPPORTING PANEL SIZE: 720W x 735Hmm	2 nos
WK-ML-130-D2	SLIDING HALF HEIGHT CABINET SIZE: 900W x 450D x 1300Hmm	4 nos
WK-ML-76-D2	SLIDING DOOR CABINET SIZE: 750W x 450D x 760Hmm	2 nos
WK-ML-76-D1	SWING DOOR CABINET SIZE: 750W x 450D x 760Hmm	2 nos

\*FRAME COLOUR : DARK GREY  
\*THE ABOVE MODEL EXCLUDING DISPLAY ACCESSORIES

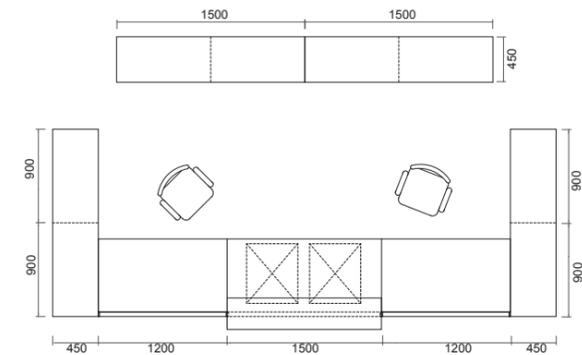

# COMBINE AND CREATE YOUR OWN WORKPLACE

## FULL GLASS PARTITION

a fully glass wall that serve several functions where separation of different areas improves and optimises productivity

\*can choose frosted type of glass

## PARTITION

a wall that separates space to create a part, division and section in workplace area.

- \*standard thickness for partition panel is 55 mm
- \*can choose type and size of partition
- \*various fabric colors can be chosen

## HANGING CABINET

in order to maximize space and ensuring your office table is not cluttered up and messy, it is usually used to store your files, books, paperwork and important stuff.

\*various colours of the door can be chosen

## HANGING BOOKSHELF

15kg -  
the maximum  
load it can support



## MCAB EXECUTIVE

design for higher ranking office that require style and comfort for a more confident and elegant office furniture.

\*various colors of table top can be chosen

## MCAB 2 SEATER

\*various colors of table top can be chosen

## WIRE TRUNKING

the wiring management system is facilitating the installation of multifunction socket, wiring conduit can accommodate all powerlines, data lines, network lines and telephone lines

# WIRE MANAGEMENT

the s-system organize the wiring to be brought out two position, either above table top or bottom raceway which is convenient for people to access the device that require consistent power sources. the completely hidden wire management in the 54mm thickness panel present a neat and aesthetic visualization.

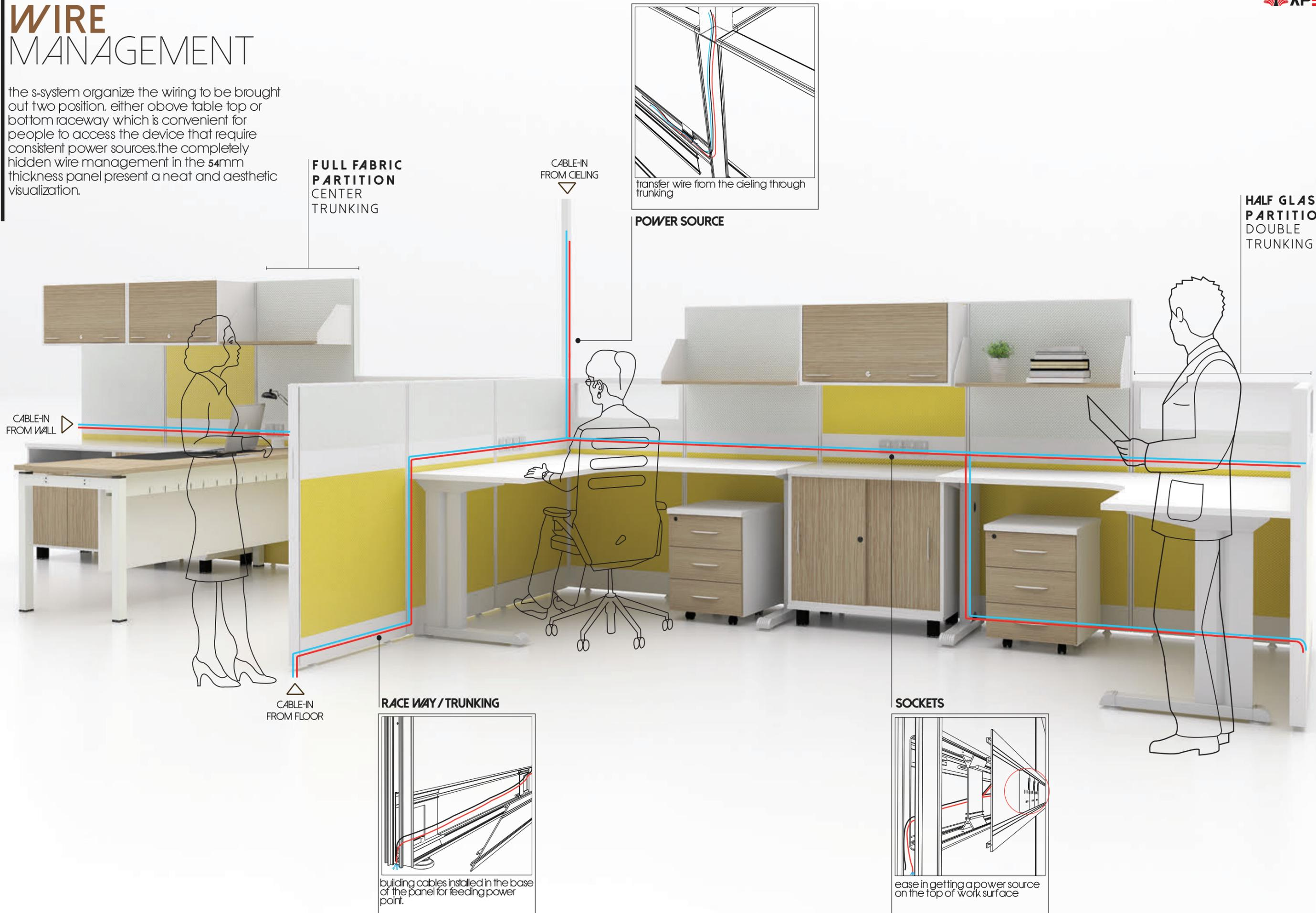

**FULL FABRIC PARTITION CENTER TRUNKING**

CABLE-IN FROM CEILING

**POWER SOURCE**

**HALF GLASS PARTITION DOUBLE TRUNKING**

CABLE-IN FROM WALL

CABLE-IN FROM FLOOR

**RACE WAY / TRUNKING**

**SOCKETS**

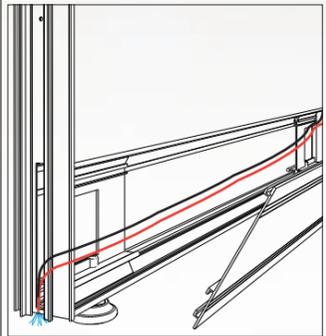

building cables installed in the base of the panel for feeding power point.

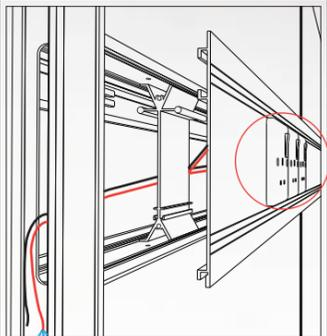

ease in getting a power source on the top of work surface

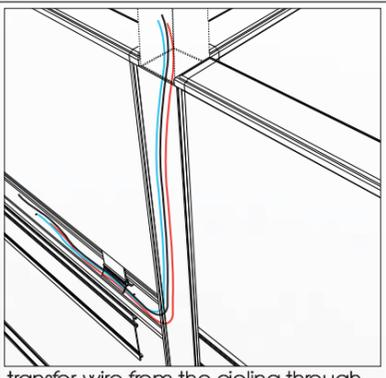

transfer wire from the ceiling through trunking







### Full Glass without Trunking (PT-FGOT)

#### Height : 1200 mm

PT-FGOT - 120 X 45	1200H x 450W mm
PT-FGOT - 120 X 60	1200H x 600W mm
PT-FGOT - 120 X 75	1200H x 750W mm
PT-FGOT - 120 X 80	1200H x 800W mm
PT-FGOT - 120 X 90	1200H x 900W mm
PT-FGOT - 120 X 120	1200H x 1200W mm

#### Height : 1650 mm

PT-FGOT - 165 X 45	1650H x 450W mm
PT-FGOT - 165 X 60	1650H x 600W mm
PT-FGOT - 165 X 75	1650H x 750W mm
PT-FGOT - 165 X 80	1650H x 800W mm
PT-FGOT - 165 X 90	1650H x 900W mm
PT-FGOT - 165 X 120	1650H x 1200W mm

#### Height : 1350 mm

PT-FGOT - 135 X 45	1350H x 450W mm
PT-FGOT - 135 X 60	1350H x 600W mm
PT-FGOT - 135 X 75	1350H x 750W mm
PT-FGOT - 135 X 80	1350H x 800W mm
PT-FGOT - 135 X 90	1350H x 900W mm
PT-FGOT - 135 X 120	1350H x 1200W mm

#### Height : 1500 mm

PT-FGOT - 150 X 45	1500H x 450W mm
PT-FGOT - 150 X 60	1500H x 600W mm
PT-FGOT - 150 X 75	1500H x 750W mm
PT-FGOT - 150 X 80	1500H x 800W mm
PT-FGOT - 150 X 90	1500H x 900W mm
PT-FGOT - 150 X 120	1500H x 1200W mm



### Full Glass c/w Bottom Trunking (PT-FGBT)

#### Height : 1200 mm

PT-FGBT - 120 X 45	1200H x 450W mm
PT-FGBT - 120 X 60	1200H x 600W mm
PT-FGBT - 120 X 75	1200H x 750W mm
PT-FGBT - 120 X 80	1200H x 800W mm
PT-FGBT - 120 X 90	1200H x 900W mm
PT-FGBT - 120 X 120	1200H x 1200W mm

#### Height : 1650 mm

PT-FGBT - 165 X 45	1650H x 450W mm
PT-FGBT - 165 X 60	1650H x 600W mm
PT-FGBT - 165 X 75	1650H x 750W mm
PT-FGBT - 165 X 80	1650H x 800W mm
PT-FGBT - 165 X 90	1650H x 900W mm
PT-FGBT - 165 X 120	1650H x 1200W mm

#### Height : 1350 mm

PT-FGBT - 135 X 45	1350H x 450W mm
PT-FGBT - 135 X 60	1350H x 600W mm
PT-FGBT - 135 X 75	1350H x 750W mm
PT-FGBT - 135 X 80	1350H x 800W mm
PT-FGBT - 135 X 90	1350H x 900W mm
PT-FGBT - 135 X 120	1350H x 1200W mm

#### Height : 1800 mm

PT-FGBT - 180 X 45	1800H x 450W mm
PT-FGBT - 180 X 60	1800H x 600W mm
PT-FGBT - 180 X 75	1800H x 750W mm
PT-FGBT - 180 X 80	1800H x 800W mm
PT-FGBT - 180 X 90	1800H x 900W mm
PT-FGBT - 180 X 120	1800H x 1200W mm

#### Height : 1500 mm

PT-FGBT - 150 X 45	1500H x 450W mm
PT-FGBT - 150 X 60	1500H x 600W mm
PT-FGBT - 150 X 75	1500H x 750W mm
PT-FGBT - 150 X 80	1500H x 800W mm
PT-FGBT - 150 X 90	1500H x 900W mm
PT-FGBT - 150 X 120	1500H x 1200W mm

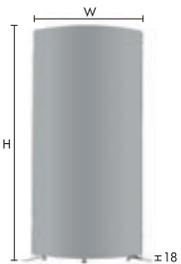

### Curve Full Fabric (PT-CFF)

#### Height : 1050 mm

PT-CFF - 105 X 60	1050H x 600W mm
PT-CFF - 105 X 75	1050H x 750W mm

#### Height : 1500 mm

PT-CFF - 150 X 60	1500H x 600W mm
PT-CFF - 150 X 75	1500H x 750W mm

#### Height : 1200 mm

PT-CFF - 120 X 60	1200H x 600W mm
PT-CFF - 120 X 75	1200H x 750W mm

#### Height : 1350 mm

PT-CFF - 135 X 60	1350H x 600W mm
PT-CFF - 135 X 75	1350H x 750W mm



### Curve Half Perspex (PT-CHP)

#### Height : 1200 mm

PT-CHP - 120 X 60	1200H x 600W mm
PT-CHP - 120 X 75	1200H x 750W mm

#### Height : 1350 mm

PT-CHP - 135 X 60	1350H x 600W mm
PT-CHP - 135 X 75	1350H x 750W mm

#### Height : 1500 mm

PT-CHP - 150 X 60	1500H x 600W mm
PT-CHP - 150 X 75	1500H x 750W mm



### Curve Full Perspex (PT-CFP)

#### Height : 1200 mm

PT-CFP - 120 X 60	1200H x 600W mm
PT-CFP - 120 X 75	1200H x 750W mm

#### Height : 1350 mm

PT-CFP - 135 X 60	1350H x 600W mm
PT-CFP - 135 X 75	1350H x 750W mm

#### Height : 1500 mm

PT-CFP - 150 X 60	1500H x 600W mm
PT-CFP - 150 X 75	1500H x 750W mm

**TABLE TOP**

**Straight Worktop**

WK-WT 60 X 45	600W x 450D x 25THK mm	WK-WT 165 X 60	1650W x 600D x 25THK mm
WK-WT 75 X 45	750W x 450D x 25THK mm	WK-WT 180 X 60	1800W x 600D x 25THK mm
WK-WT 90 X 45	900W x 450D x 25THK mm	WK-WT 60 X 75	600W x 750D x 25THK mm
WK-WT 105 X 45	1050W x 450D x 25THK mm	WK-WT 75 X 75	750W x 750D x 25THK mm
WK-WT 120 X 45	1200W x 450D x 25THK mm	WK-WT 90 X 75	900W x 750D x 25THK mm
WK-WT 60 X 60	600W x 600D x 25THK mm	WK-WT 105 X 75	1050W x 750D x 25THK mm
WK-WT 75 X 60	750W x 600D x 25THK mm	WK-WT 120 X 75	1200W x 750D x 25THK mm
WK-WT 90 X 60	900W x 600D x 25THK mm	WK-WT 135 X 75	1350W x 750D x 25THK mm
WK-WT 105 X 60	1050W x 600D x 25THK mm	WK-WT 150 X 75	1500W x 750D x 25THK mm
WK-WT 120 X 60	1200W x 600D x 25THK mm	WK-WT 165 X 75	1650W x 750D x 25THK mm
WK-WT 135 X 60	1350W x 600D x 25THK mm	WK-WT 180 X 75	1800W x 750D x 25THK mm
WK-WT 150 X 60	1500W x 600D x 25THK mm		

**Curve Corner Worktop**

WK-CC 150 X 60	1500W/600D x 1500W/600D x 25THK mm
WK-CC 165 X 60	1650W/600D x 1650W/600D x 25THK mm
WK-CC 180 X 75	1500W/750D x 1500W/750D x 25THK mm
WK-CC 165 X 75	1650W/750D x 1650W/750D x 25THK mm

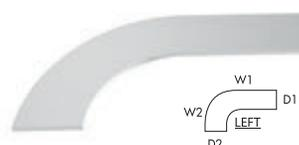
**Curve Counter Top (Left)**

WK-CC 120 X 60 (L)	1375W/300D x 775W/300D x 25THK mm
WK-CC 150 X 60 (L)	1675W/300D x 775W/300D x 25THK mm
WK-CC 180 X 60 (L)	1975W/300D x 775W/300D x 25THK mm
WK-CC 120 X 75 (L)	1375W/300D x 925W/300D x 25THK mm
WK-CC 150 X 75 (L)	1675W/300D x 925W/300D x 25THK mm
WK-CC 180 X 75 (L)	1975W/300D x 925W/300D x 25THK mm

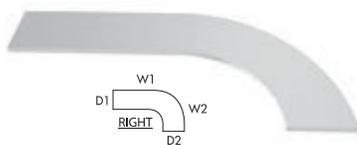
**Curve Counter Top (Right)**

WK-CC 120 X 60 (R)	1375W/300D x 775W/300D x 25THK mm
WK-CC 150 X 60 (R)	1675W/300D x 775W/300D x 25THK mm
WK-CC 180 X 60 (R)	1975W/300D x 775W/300D x 25THK mm
WK-CC 120 X 75 (R)	1375W/300D x 925W/300D x 25THK mm
WK-CC 150 X 75 (R)	1675W/300D x 925W/300D x 25THK mm
WK-CC 180 X 75 (R)	1975W/300D x 925W/300D x 25THK mm

**Round End Top**

WK-RET 120 X 60	1200W x 600D x 25THK mm
WK-RET 150 X 60	1500W x 600D x 25THK mm
WK-RET 180 X 60	1800W x 600D x 25THK mm
WK-RET 120 X 75	1200W x 750D x 25THK mm
WK-RET 150 X 75	1500W x 750D x 25THK mm
WK-RET 180 X 75	1800W x 750D x 25THK mm

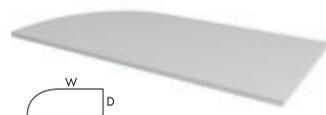
**Counter Worktop (Left)**

WK-CW 120 X 60 (L)	1200W x 600D x 25THK mm
WK-CW 150 X 60 (L)	1500W x 600D x 25THK mm
WK-CW 180 X 60 (L)	1800W x 600D x 25THK mm
WK-CW 120 X 75 (L)	1200W x 750D x 25THK mm
WK-CW 150 X 75 (L)	1500W x 750D x 25THK mm
WK-CW 180 X 75 (L)	1800W x 750D x 25THK mm

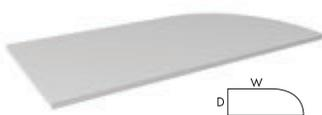
**Counter Worktop (Right)**

WK-CW 120 X 60 (R)	1200W x 600D x 25THK mm
WK-CW 150 X 60 (R)	1500W x 600D x 25THK mm
WK-CW 180 X 60 (R)	1800W x 600D x 25THK mm
WK-CW 120 X 75 (R)	1200W x 750D x 25THK mm
WK-CW 150 X 75 (R)	1500W x 750D x 25THK mm
WK-CW 180 X 75 (R)	1800W x 750D x 25THK mm

**Round Extension Top (Left)**

WK-RXT 60 (L)	750W x 600D x 25THK mm
WK-RXT 75 (L)	900W x 750D x 25THK mm

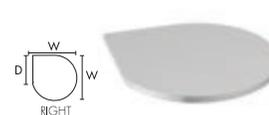
**Round Extension Top (Right)**

WK-RXT 60 (R)	750W x 600D x 25THK mm
WK-RXT 75 (R)	900W x 750D x 25THK mm

**Connection Worktop**

WK-CNW 60	600W x 600D x 25THK mm
WK-CNW 75	750W x 750D x 25THK mm

**Half Round Top**

WK-HRT 95	475W x 950D x 25THK mm
WK-HRT 125	625W x 1250D x 25THK mm
WK-HRT 155	775W x 1550D x 25THK mm

**Semi-Oval Worktop**

WK-SOW 180 X 60	1800W x 600D x 25THK mm
WK-SOW 210 X 60	2100W x 600D x 25THK mm
WK-SOW 240 X 60	2400W x 600D x 25THK mm
WK-SOW 210 X 75	2100W x 750D x 25THK mm
WK-SOW 240 X 75	2400W x 750D x 25THK mm

**120° Hexagon Worktop**

WK-HWT	430W x 25THK mm
--------	-----------------

**Corner Worktop**

WK-CWT 90 X 45	900W/450D x 900W/450D x 25THK mm
WK-CWT 90 X 60	900W/600D x 900W/600D x 25THK mm
WK-CWT 90 X 75	900W/750D x 900W/750D x 25THK mm
WK-CWT 105 X 45	1050W/450D x 1050W/450D x 25THK mm
WK-CWT 105 X 60	1050W/600D x 1050W/600D x 25THK mm
WK-CWT 105 X 75	1050W/750D x 1050W/750D x 25THK mm
WK-CWT 120 X 60	1200W/600D x 1200W/600D x 25THK mm
WK-CWT 120 X 75	1200W/750D x 1200W/750D x 25THK mm



**Counter Top**

WK-C 45 X 30	450W x 300D x 25THK mm
WK-C 60 X 30	600W x 300D x 25THK mm
WK-C 75 X 30	750W x 300D x 25THK mm
WK-C 90 X 30	900W x 300D x 25THK mm
WK-C 120 X 30	1200W x 300D x 25THK mm
WK-C 150 X 30	1500W x 300D x 25THK mm
WK-C 180 X 30	1800W x 300D x 25THK mm

**Trapezium Worktop**

WK-TWT	1072W/660D x 330L/660D x 25THK mm
--------	-----------------------------------

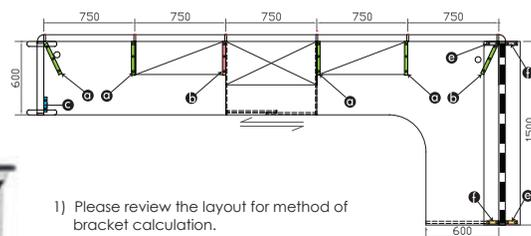
## BRACKET



- 1) Please review the layout for method of bracket calculation.
- 2) The right of left is identified based on individual facing seat of A,B & C in layout.
- 3) The center bracket of eye view can be standardized using PT-BK-01-F (Left Hand Bracket)



### Table Mounting Bracket

- ⓐ PT-BK-01-F LEFT BRACKET (BIG)  
387W x 167H mm
- ⓑ PT-BK-02-F RIGHT BRACKET (BIG)  
387W x 167H mm



### Table Mounting Bracket

- ⓒ PT-BK-03-F LEFT BRACKET (SMALL)  
90W x 75H mm
- ⓓ PT-BK-04-F RIGHT BRACKET (SMALL)  
90W x 75H mm



### Counter Support Bracket

- ⓔ PT-BK-05-F COUNTER BRACKET (LEFT)  
90W x 75H mm
- ⓕ PT-BK-06-F COUNTER BRACKET (RIGHT)  
90W x 75H mm

### BRACKET POSITION



TABLE MOUNTING BRACKET



TABLE MOUNTING BRACKET

COUNTER SUPPORT BRACKET

## ACCESSORIES



### Hanging Cabinet - Flip Door Type

WK-HC 60	585W x 355D x 445H mm
WK-HC 75	735W x 355D x 445H mm
WK-HC 90	885W x 355D x 445H mm
WK-HC 105	1035W x 355D x 445H mm
WK-HC 120	1185W x 355D x 445H mm



### Hanging Cabinet - Flip Door Type With Soft Closing

WK-HC 60 (SF)	585W x 355D x 445H mm
WK-HC 75 (SF)	735W x 355D x 445H mm
WK-HC 80 (SF)	785W x 355D x 445H mm
WK-HC 90 (SF)	885W x 355D x 445H mm
WK-HC 105 (SF)	1035W x 355D x 445H mm
WK-HC 120 (SF)	1185W x 355D x 445H mm



### Hanging Bookshelf

WK-HB 60	585W x 320D x 240H mm
WK-HB 75	735W x 320D x 240H mm
WK-HB 80	785W x 320D x 240H mm
WK-HB 90	885W x 320D x 240H mm
WK-HB 105	1035W x 320D x 240H mm



### Side Supporting Panel

WK-SL 45	420W x 735H mm
WK-SL 60	570W x 735H mm
WK-SL 75	720W x 735H mm



### Cantilever Leg

PT-CT 45	450W x 735H mm
PT-CT 60	600W x 735H mm
PT-CT 75	750W x 735H mm



### Tubular Stand

RD-ETS	50W x 50D x 735H mm
--------	---------------------



### Tubular Stand

WK-TS	75W x 75D x 735H mm
-------	---------------------



### RD-02 (L) RD-02 (R)

600W x 62D x 735H mm
----------------------



### RD-05

600W x 70D x 735H mm
----------------------



### RD-06

600W x 70D x 735H mm
----------------------



### RD-09 (L) RD-09 (R)

600W x 62D x 735H mm
----------------------



### RD-10

600W x 70D x 735H mm
----------------------

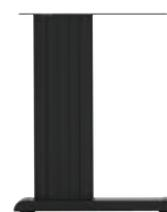

### RD-11

600W x 70D x 735H mm
----------------------